

YOUR AUTHORIZED PACKAGER

COBEY®

ONE SHIP CANAL PARKWAY • BUFFALO, NY 14218
PH: +1.716.362.9550 • WWW.COBEY.COM

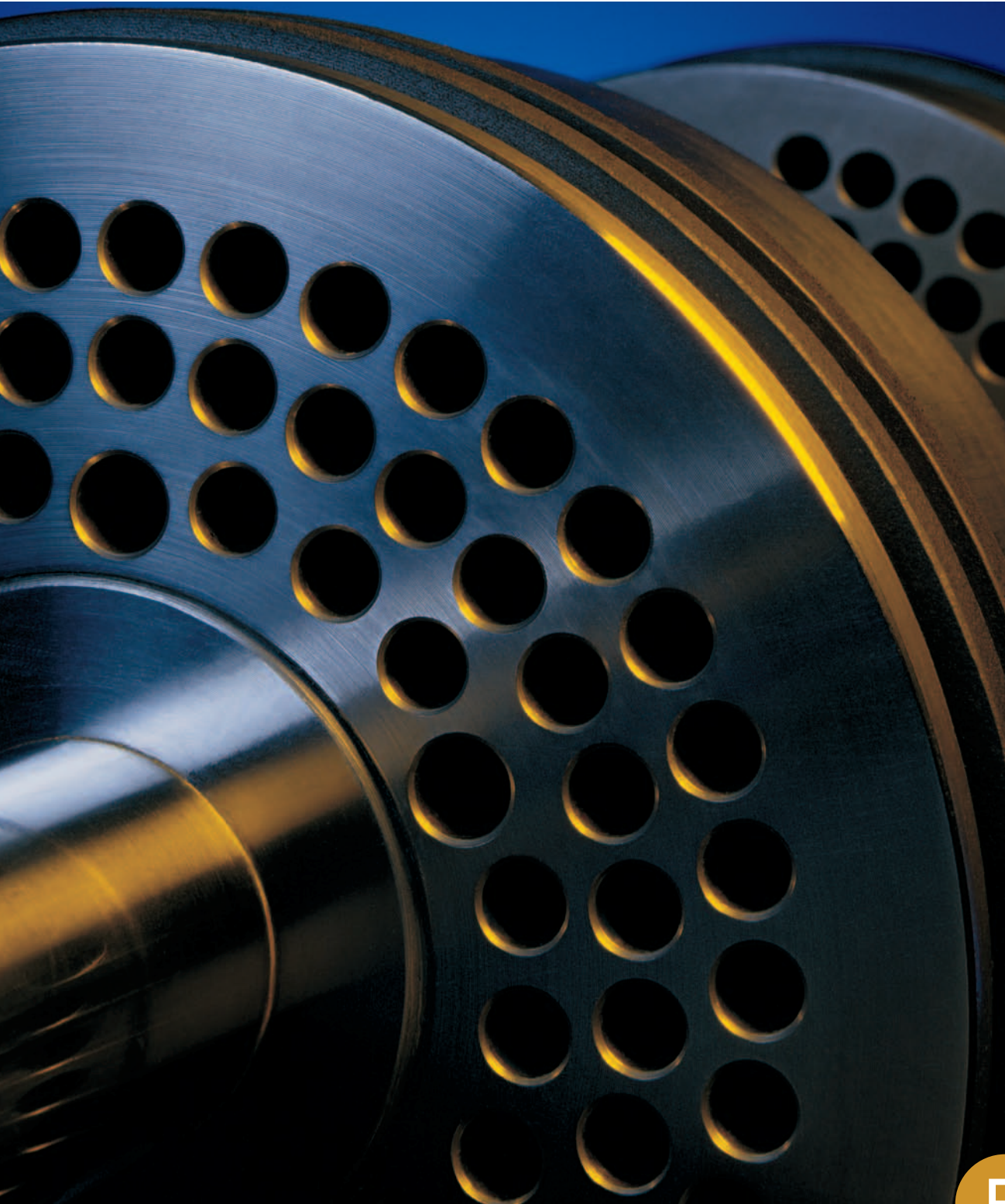

B

DRESSER-RAND

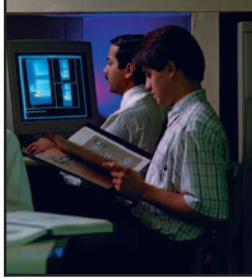

B-VIP compressors

*Every component of the
VIP frame is designed to
provide built-in reliability
and simplicity.*

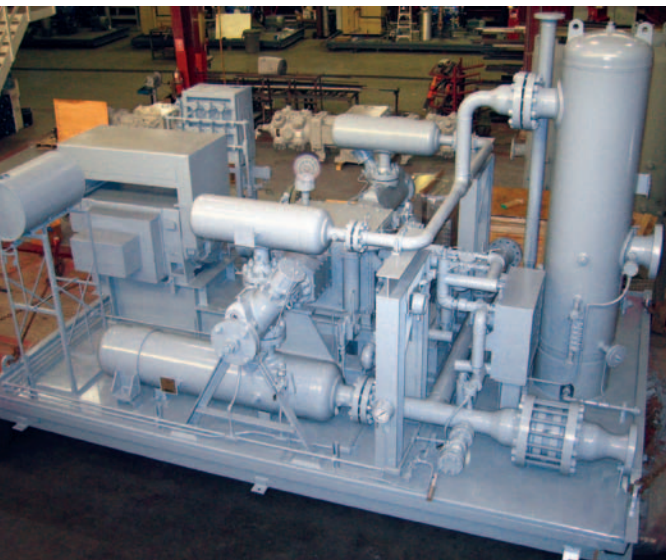

The VIP cylinder incorporates advanced technology that is matched by our proven frame. The 5B-VIP compressor has a 5" (127 mm) stroke and is rated up to 2125 hp (1585 kW) at a maximum 1500 rpm. The 6B-VIP compressor has a 6" (152.4 mm) stroke and is rated up to 1700 hp (1268 kW) at 1200 rpm.

Every component of the frame is designed to provide built-in reliability and simplicity. This rugged frame, available with two or four cranks, has proven itself in years of tough gas field service. It is available in two or four throws and is an ideal match for the VIP cylinder. Here's why.

Oil scraper and packing rings can be easily inspected and serviced through side openings in the crosshead guide housings.

Exclusive Dresser-Rand PF valves with Hi-Temp™ plates are used to improve gas flow and efficiency, and to provide longer operating life.

The Dresser-Rand VIP compressor design eliminates the conventional piston, replacing it with a combination piston-valve that significantly reduces reciprocating weights. This allows higher rotative speeds at shorter strokes without inertia loading. The result is a highly efficient, smooth running compressor.

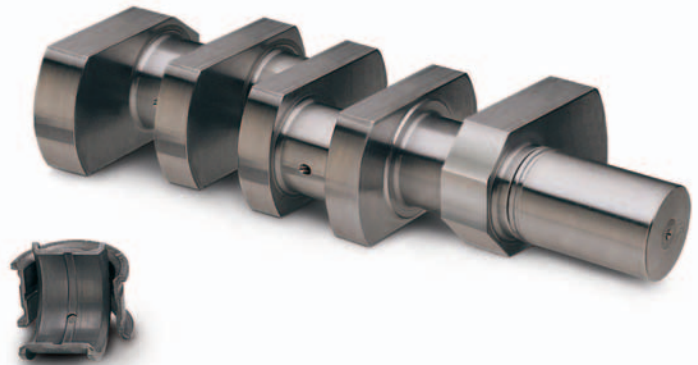

Dresser-Rand rugged frame and co



The forged steel crankshaft is proven for 1,500 rpm operation in tough gas field service. Throws are set at 180 degrees (90 degrees with four throws) and the crankshaft is counterweighted to reduce horizontal moments.

Aluminum precision-insert main bearings are specifically designed to meet the demands of VIP compressor operation.

The patented I-beam crossheads are lightweight, single-piece nodular iron with pressure lubrication to the wearing surfaces. A variety of cross-head balance weights is available to meet all balancing requirements.

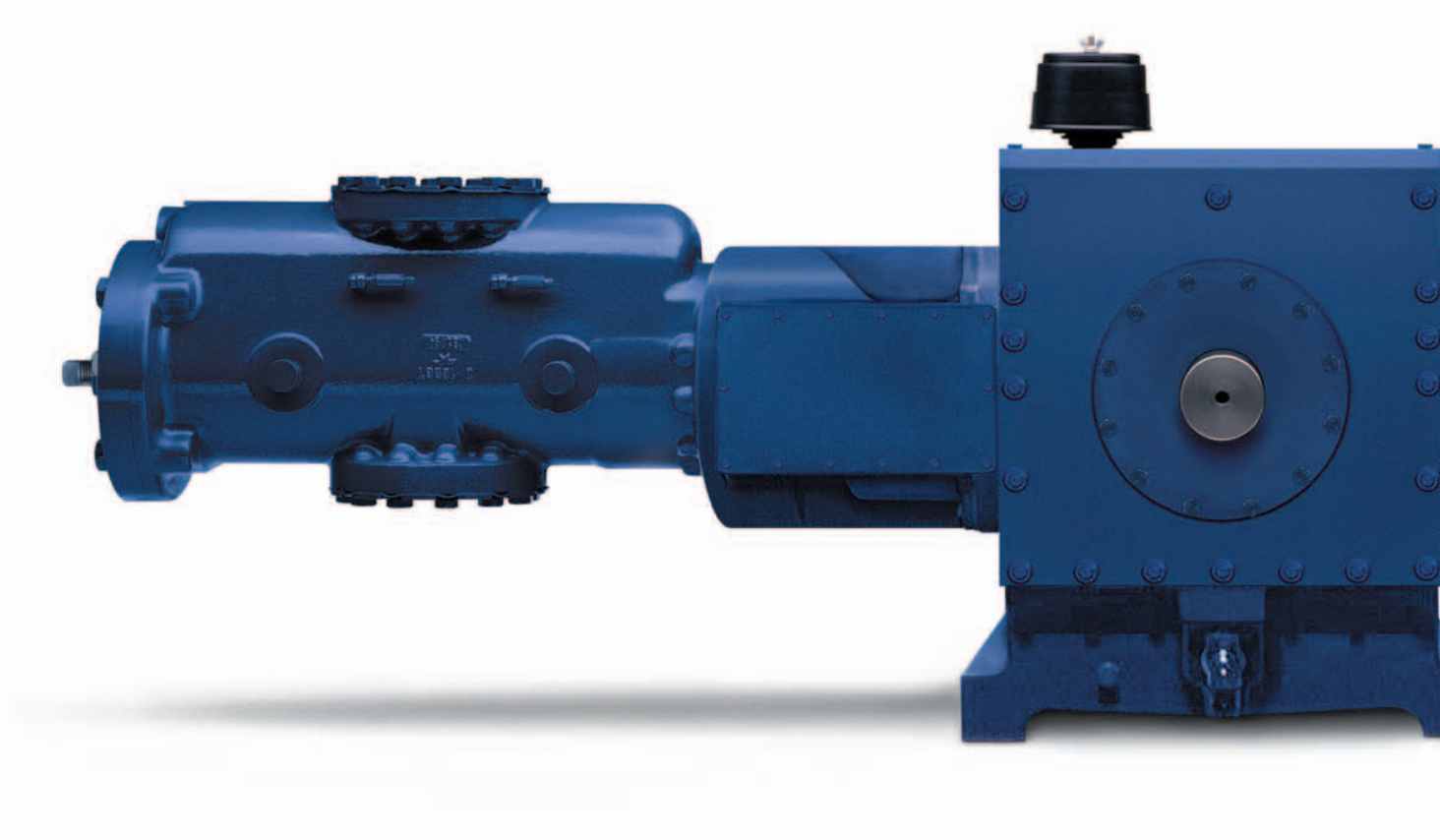

Components enhance VIP reliability.



The B-VIP compressor frame incorporates a gear-and-crescent-type oil pump driven directly from the crankshaft by chain and sprockets. This provides full-pressure lubrication to the running gear and cross-head. Oil pressure is maintained with an integral pressure regulator relief valve.

Rod loads are transmitted directly to forged steel connecting rods through high-strength carbon steel connecting rod pins contained within aluminum alloy connecting rod bushings. Rod bearings are tri-metal bronze, precision-insert for durable, long-term operation.



RATINGS

Model	Stroke in. (mm)	Number of Cylinders	Nominal Rated Power hp (kW)	Max. Allowable Rod Load lbs. (kN)	Rated rpm
6B-VIP2	6 152.4	2	850 (634)	24200 (108)	1200
6B-VIP4	6 152.4	4	1700 (1268)	24200 (108)	1200
5B-VIP2	5 127	2	1062 (792)	24200 (108)	1500
5B-VIP4	5 127	4	2125 (1585)	24200 (108)	1500

Cylinder Size in. (mm)	MAWP psig(kg/cm ²)	Piston Displacement			
		6" (152.4 mm) Stroke @ 1000 rpm CFM (m ³ /hr.)	6" (152.4 mm) Stroke @ 1200 rpm CFM (m ³ /hr.)	5" (127 mm) Stroke @ 1500 rpm CFM (m ³ /hr.)	5" (127 mm) Stroke @ 1200 rpm CFM (m ³ /hr.)
4.25 (108.0)	2250 (158.2)	88 (150)	105 (179)	110 (187)	88 (150)
5 (127.0)	2250 (158.2)	125 (213)	151 (257)	157 (267)	125 (213)
5.5 (139.7)	1925 (135.4)	154 (262)	185 (315)	193 (329)	154 (262)
6 (152.4)	1925 (135.4)	185 (315)	223 (380)	232 (395)	185 (315)
6.5 (165.1)	1375 (96.7)	220 (375)	263 (448)	274 (467)	220 (375)
7.125 (181.0)	1375 (96.7)	266 (453)	319 (543)	332 (565)	266 (453)
7.75 (196.9)	1150 (80.9)	317 (540)	380 (647)	396 (674)	317 (540)
8.5 (215.9)	1150 (80.9)	383 (652)	460 (783)	479 (816)	383 (652)
9.25 (235.0)	750 (52.7)	456 (777)	547 (932)	570 (971)	456 (777)
10 (254.0)	750 (52.7)	535 (911)	641 (1092)	668 (1138)	535 (911)
11.25 (285.8)	495 (34.8)	679 (1156)	815 (1388)	815 (1388)	679 (1156)
12.5 (317.5)	495 (34.8)	841 (1432)	1010 (1720)		841 (1432)
13.75 (349.3)	275 (19.3)	1020 (1737)	224 (2084)		1020 (1737)
15 (381.0)	275 (19.3)	1216 (2071)	1460 (2486)		1216 (2071)
16.25 (412.8)	215 (15.1)	1429 (2434)	1715 (2921)		1429 (2434)
17.5 (444.5)	215 (15.1)	1659 (2825)	1991 (3391)		1659 (2825)
19 (482.6)	215 (15.1)	1958 (3334)	2350 (4002)		
20.5 (520.7)	215 (15.1)	2281 (3885)	2737 (4661)		

Model	A in. (mm)	B in. (mm)	C in. (mm)	D in. (mm)
B-VIP2	46.94 (1192.3)	41.5 (1054.1)	67 (1701.8)	39.41 (1001.0)
B-VIP4	46.94 (1192.3)	79.5 (2019.3)	67 (1701.8)	39.41 (1001.0)

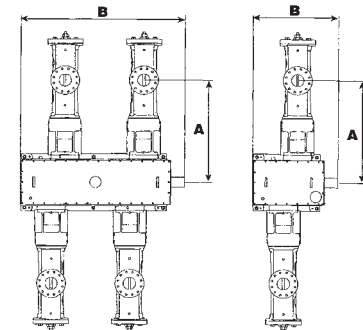
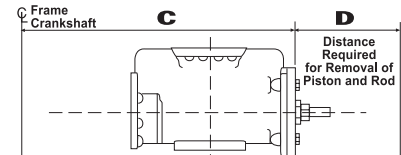

Compressor Frame

- Rugged cast gray iron frame with bolt-on crosshead guides
- Frame inspection openings with steel covers
- Heavy duty balanced forged steel crankshaft
- Forged steel connecting rods
- Patented nodular iron I-beam crossheads
- Horizontally split precision type aluminum alloy main bearings
- Horizontally split tri-metal crankpin bearings
- Aluminum alloy connecting rod bushings
- AISI 4142 steel connecting rod pin
- Crankcase filter-breather
- Metallic oil wiper rings
- Main lube oil pump directly driven from crankshaft complete with relief valve
- Single full-flow lube oil filter
- Shell-and-tube lube oil cooler
- All frame lube oil piping is stainless steel downstream of the filter
- Bulls-eye oil level gauge
- Oil pressure gauge for frame lube oil
- Hand-operated frame mounted prelube pump
- Forced fed cylinder lubrication system
- Set of special tools consisting of crosshead nut wrench, piston rod entering sleeve, valve disassembly tool, hex tools and extension socket

Compressor Cylinder

- Cast nodular iron cylinder barrel with integral crank end head for cylinder bores 4.25" (108.0 mm) through 5" (127.0 mm)
- Cast gray iron cylinder barrel with integral crank end head for cylinder bores 5.5" (139.7 mm) through 20.5" (520.7 mm)
- Manually operated variable volume clearance pocket
- AISI 4142 steel piston rods
- AISI 4142 steel suction and discharge valves (piston)
- PF-style plate valves complete with Hi-Temp, non-metallic PEEK plates and chrome silicon springs with Teflon[®] spring inserts
- Teflon[®] piston rings and riders for bore sizes 4.25" (127.0 mm) to 10" (254.0 mm)
- Carbon glass carbon filled Teflon[®] rings for bore sizes above 10" (254.0 mm) combination ring type
- Carbon filled Teflon[®] piston rod packing rings
- .75 NPT plugged connections for indicator ports on outer end and frame end of all cylinders
- .75 NPT plugged connections for temperature thermowell on outer end and frame end inlet passage
- Inlet and discharge connections on all cylinders are standard ANSI F.F. flanges
- Six sets of parts lists and operating manuals
- One reproducible print of certified outline drawings (or furnished in electronic format)

Optional Features

- Carpenter Custom 450[®] piston rods with D-R TC3 coating
- Annealed 4142 piston rods with D-R TC3 coating
- Crankcase and lubricator oil heaters
- Crankcase explosion relief devices
- Dynamic valve analysis
- API 618 Type A, B, C, and D distance piece
- Purged packing case
- Pump to point cylinder lubrication
- Main bearing RTD's
- Torsional studies
- Flywheel (if required)
- Dual oil filter
- Liquid level controller
- Balance cylinders
- Purged wiper case

DRESSER-RAND

YOUR AUTHORIZED PACKAGER

COBEY®

ONE SHIP CANAL PARKWAY • BUFFALO, NY 14218
PH: +1.716.362.9550 • WWW.COBEY.COM

For more information on the B-VIP compressor, visit us on the Internet at www.dresser-rand.com/gfc or contact us at:

**Dresser-Rand Company
Gas Field Compressors**
1354 South Sheridan Road
Tulsa, Oklahoma 74112-5416
USA
Phone: (918) 254-4099
Fax: (918) 252-9055
E-mail: GFC@dresser-rand.com

**Dresser-Rand Company
Reciprocating Operations**
100 Chemung Street
Painted Post, NY 14870
USA
Phone: (607) 937-2011
Fax: (607) 937-2905

For a complete list of D-R products and services, visit us on the Internet at www.dresser-rand.com or contact us at the following locations:

Company Headquarters

Dresser-Rand Company
1200 West Sam Houston Pkwy. N.
Houston, TX 77043
Tel: 713-467-2221
Fax: 713-935-3490
email: info@dresser-rand.com

Regional Headquarters

The Americas

Dresser-Rand Company
1200 West Sam Houston Pkwy. N.
Houston, TX 77043
Tel: 713-467-2221
Fax: 713-935-3490

European Served Areas (ESA)

(Europe, Eurasia, Middle East, Africa)
Dresser-Rand S.A.
31 Boulevard Winston Churchill
Cedex 7013
Le Havre 76080 France
Tel: 33-2-35-25-5225
Fax: 33-2-35-25-5366 / 5367

Asia-Pacific

Dresser-Rand Asia Pacific Sdn Bhd
Unit 8-1, 8th Floor
Bangunan Malaysian Re
17 Lorong Dungun
Damansara Heights
50490 Kuala Lumpur, Malaysia
Tel: 603-2093-6633
Fax: 603-2093-2622

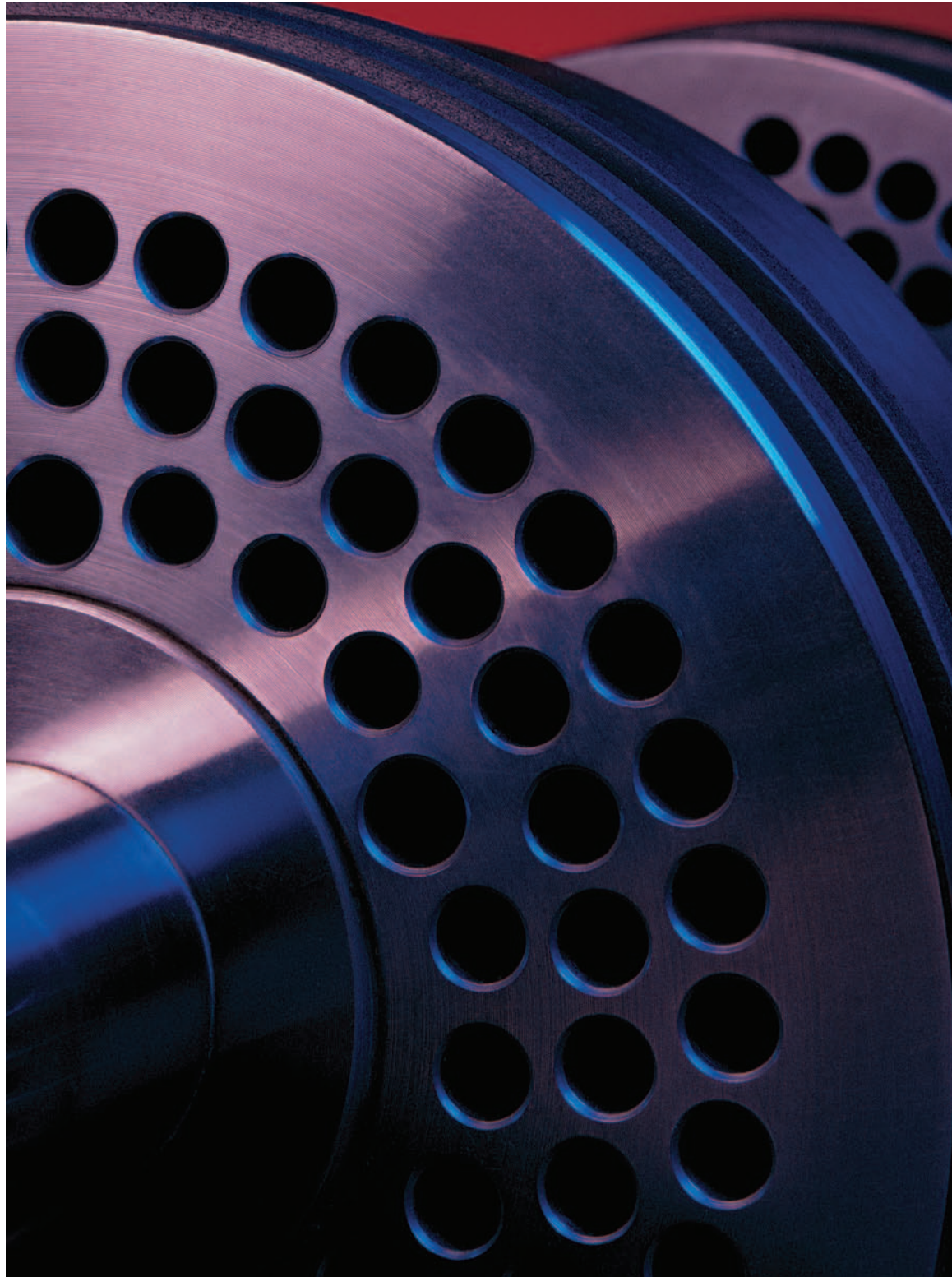

©2004 Dresser-Rand Company. Printed in U.S.A. Form 85201

This document comprises a general overview of the products described herein. It is solely for informational purposes, does not represent a warranty of the information contained herein and is not to be construed as an offer to sell or a solicitation to buy. Contact Dresser-Rand Company for detailed design and engineering information suitable to your specific applications. Dresser-Rand Company reserves the right to modify its products and related product information at any time without prior notice.